

Curtain Pole

Fitting Instructions

Tools you will need...



Drill

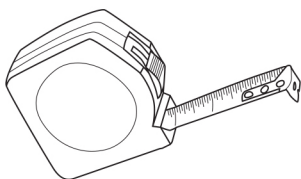

Tape Measure

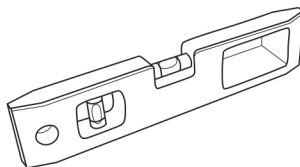

Spirit Level

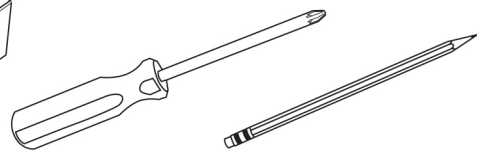

Screwdriver

Pencil

how to...

fit your curtain pole...

Step 1: As a guideline we recommend that the brackets are positioned 10cm up and 10cm out from both sides of the window frame (you may use a spirit level for accuracy). Add a centre bracket if fitting a pole length of 200cm or above.

Step 2: Remove circular screw from the front of the bracket and then position bracket on the wall where it will be fitted. Use a pencil to mark the exact position of the screw holes that will fix the brackets to the wall.

Step 3: Drill into the wall at the marked positions using an appropriate drill bit for the type of wall. Insert wall plugs, ensuring they are flush with the wall. Then screw the bracket into place using the screws provided.

Step 4: Check that the pole fits the window. If needed, cut the curtain pole to size using a hacksaw (if using 2 poles, ensure each pole is of equal length). We recommend that the pole length is long enough so that it is approx. 20cm beyond each side of the window frame. (This allows on each side 10cm to the bracket fixing, then another 10cm to the end of the pole).

Step 5: If joining two poles together, use the joiner provided. Fit the required number of rings onto the curtain pole, before positioning the pole on the brackets. Finish off by securing the pole with the circular screw from the bracket.

Step 6: Place the last ring on the outer side of the end bracket on both sides, before attaching the finial.

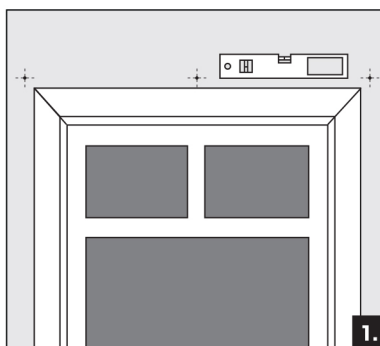

1.

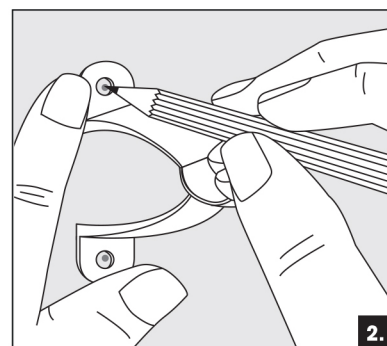

2.

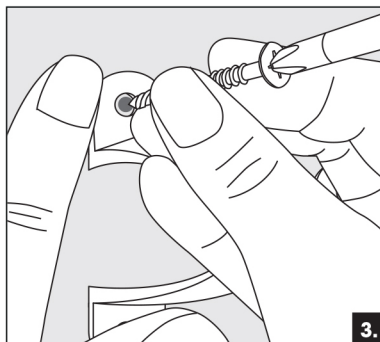

3.

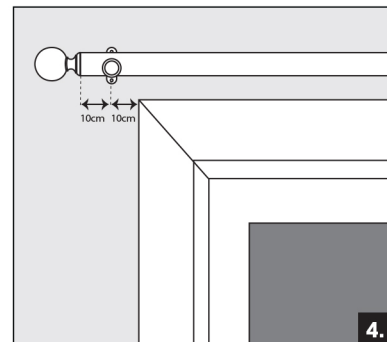

4.

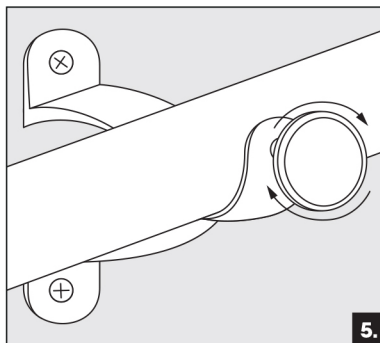

5.

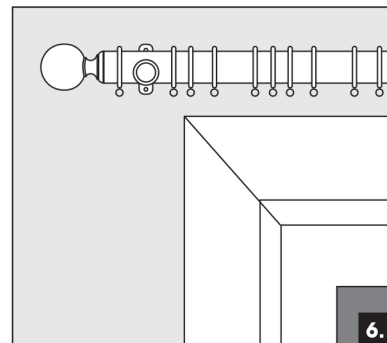

6.



HALLIS HUDSON