

Decorative Curtain Poles





Hand Operated Curtain Pole System

Silent Gliss® 6100M Metroflat 36mm

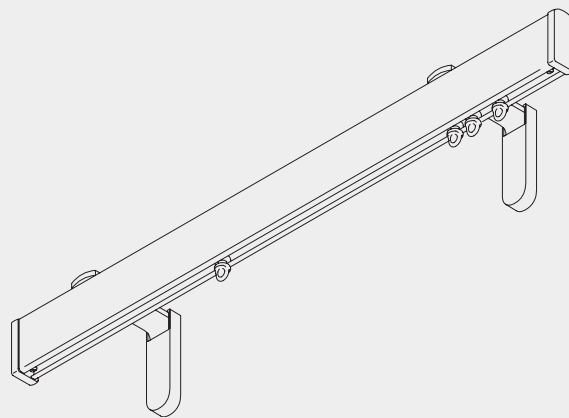

Product Information

- Hand operated system for domestic and contract applications.
- Attractive contemporary appearance for modern interiors.
- Can be bent to a small radius for bay windows.
- Available in 4 finishes - chrome effect, silver, black and gunmetal.
- Accessorised with matching endcaps and brackets / bracket covers.
- Easy fitting to wall or ceiling with choice of standard or ultra brackets.
- For light to medium curtains.
- Profile length 6m (chrome effect 4m).
- Suitable for Wave Standard and Wave XL curtain heading systems.



6100M

Profile, Bending and Specification Information

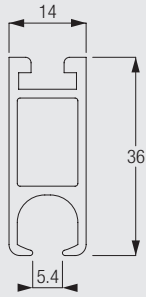

6101



Std. radius 200mm
Min. radius Wave XL: 500mm

Standard radius is recommended for optimal operation. The minimum possible radius is 150mm.

Note: It is important to observe the above minimum bending radius for Wave XL. The system will not function with a smaller radius.

Specification Information - download from the Silent Gliss Extranet

Silent Gliss 6100M curtain track, hand drawn, aluminium, assembled complete with gliders 6143 at 10/m and 2 endcovers 0710. Ceiling fix with bracket 6138P each screwed to timber/plugged and screwed to block-work/concrete at 600mm centres. Finished in black, silver, gunmetal or chrome effect.

How To Measure

Stack size calculation Wave XL

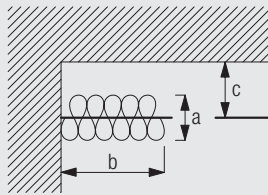

a = Stack depth 35cm
b = Stack size
c = Min. distance 22cm

System width		77-107	108-143	144-179	180-215	216-251	252-287	288-323	324-359	360-395
	b	21	26	31	36	41	46	51	56	61
System width		396-431	432-468	469-503	504-539	540-575	576-600			
	b	66	71	76	81	86	91			
System width		154-217	218-289	290-361	362-433	434-505	506-577	578-600		
	b	21	26	31	36	41	46	51		

(dimensions in cm)

6100M

System Options

Wave Standard curtain heading system

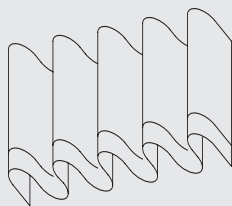

The Wave curtain heading system is an exciting new contemporary curtain heading system which allows curtains to hang in a continuous wave which is smooth, simple and elegant.

The Wave components are:

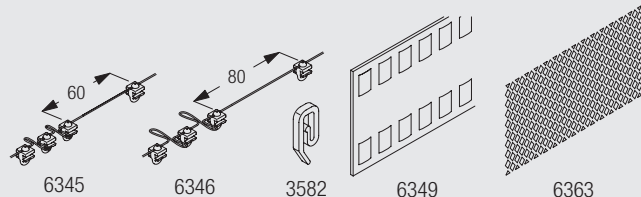

6345 Glider cord 60mm
6346 Glider cord 80mm
3582 Hook
6349 Curtain tape
6363 Iron on top hemming tape

Wave XL curtain heading system

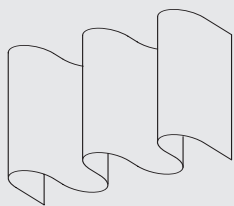

Wave XL is especially designed for high and large application areas through generously designed waves with large cross section dimensions.

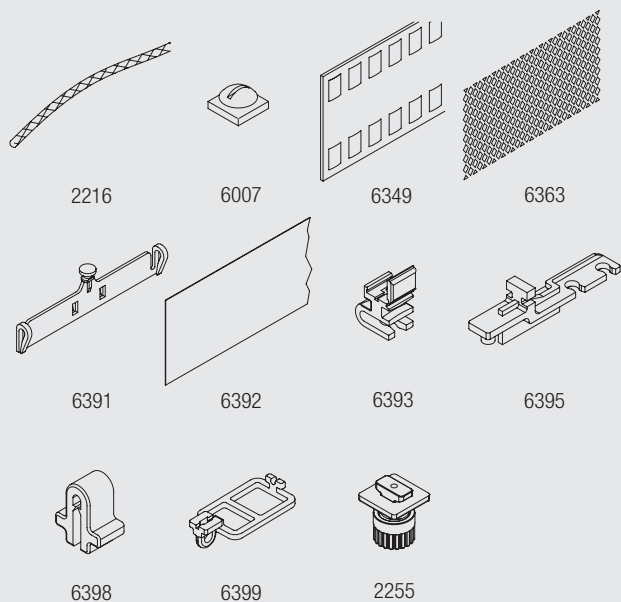

The Wave XL components are:

- 2216 Cord 0.85 mm
- 2255 Adjustable brake
- 6007 End stop
- 6349 Curtain tape
- 6363 Iron tape
- 6391 Hanger
- 6392 Heading film
- 6393 Glider
- 6395 Extension
- 6398 Clip
- 6399 Carrier for draw rod

Fitting Information

Bracket positioning when using brackets 3134/2-3136/2 or Ultra brackets 6133/6134

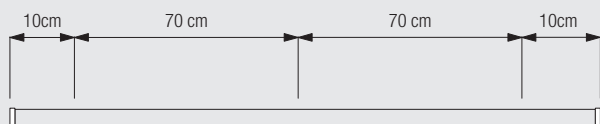

6100M

Fitting of track to brackets

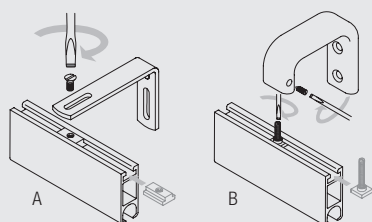

- A: Using brackets 3134/2 - 3136/2
- B: Using ultra brackets 6133 and 6134

Fitting Options

Wall fix with brackets 3134/2-3136/2

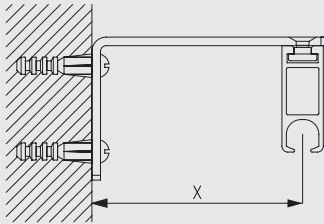

	X (mm)
3134/2	52
3135/2	72
3136/2	92

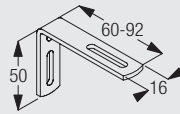

3134/2-3136/2
Extension brackets

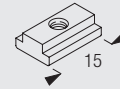

6141
Track insert

Wall fix with ultra brackets 6133 and 6134

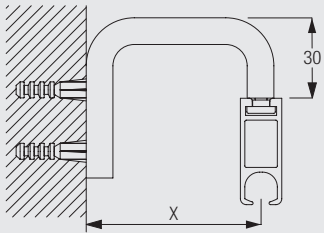

	X (mm)
6133	65
6134	105

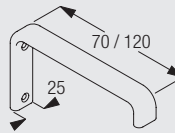

6133-34
Ultra brackets

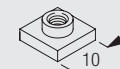

6117
Track insert

Ceiling fix with support 6138P

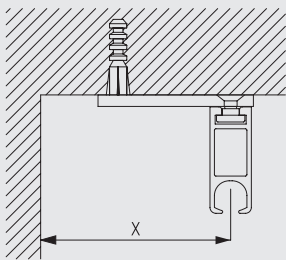

	X (mm)
	80-100

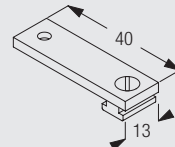

6138P
Ceiling support



6100M

The final distances may be outside of the recommendations above depending on curtain heading, make-up and any obstructions.

Min. distance from wall when using Wave XL: 220mm.

Wall fix with adjustable bracket 0537

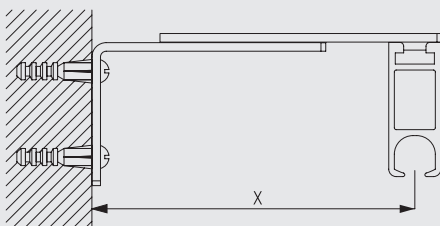

	X (mm)
0537	80-100

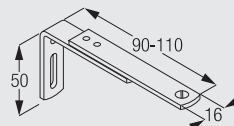

0537
Adjustable bracket

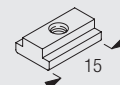

6141
Track insert

Standard Accessories

0710 Endcap



3133 Bracket cover (60mm)





3134 Extension bracket (60mm)











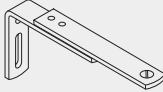







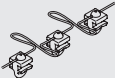



6065 Twist eye endstop

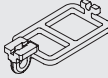

6101	Profile		6141	Track insert	
6143	Glider 6144 in strip form				

Optional Accessories

0537	Adjustable bracket		2216	Cord	
2255	Adjustable brake		3582	Hook	
6007	Endstop		6117	Track insert	
6133	Ultra bracket (70mm)		6134	Ultra bracket (120mm)	
6283	Roller glider		6345	Wave glider cord (60mm)	
6346	Wave glider cord (80mm)		6349	Wave curtain heading tape	
6363	Top hemming tape		6391	Hanger	
6392	Heading film		6393	Glider	
6395	Extension		6398	Clip	
6399	Carrier for Draw rod		3135/2	Pole extension bracket (80mm - all colours)	
3136/2	Pole extension bracket (100mm - all colours)		6138P	Ceiling support	

6100M

www.silentgliss.co.uk

Silent Gliss Ltd
Pyramid Business Park
Poorhole Lane
Broadstairs
Kent
CT10 2PT
Great Britain

Tel: 0044 (0) 1843 863571
Fax: 0044 (0) 1843 864503
sales@silentgliss.co.uk