

Hand Operated Curtain Track Systems

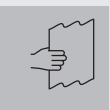



Hand Operated Curtain Track System

Silent Gliss® 1280

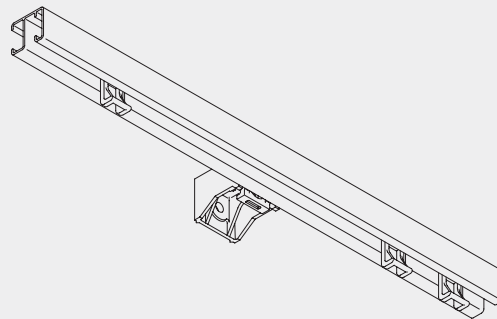

Product Information

- Versatile hand operated curtain track system for contract and domestic applications.
- For medium to heavy weight curtains.
- Patented roller gliders glide on rim of front channel with very little friction for smooth and easy operation.
- Standard profile colour: white.
- Easy wall or ceiling fixing.
- Available in 4m, 5m and 6m lengths.
- Can be bent.



1280

Profile, Bending and Specification Information

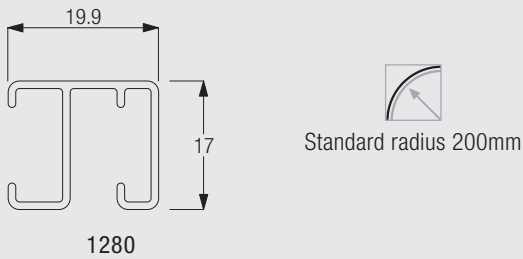

The standard radius is recommended for optimal operation. The minimum possible radius is 150mm.

Specification Guide- download from the Silent Gliss Extranet

Silent Gliss 1280 hand drawn curtain track in white powder-coated aluminium. Fix to wall with brackets 3630/3660, ceiling with brackets 3603 every 300mm. Fit endcovers 3985.

Fitting Information

Bracket positioning and fixing with universal brackets 3603, 3630, 3655, 3660



The fixing distances are meant as a guide only: they may vary in practice depending on the surface and curtain weight.

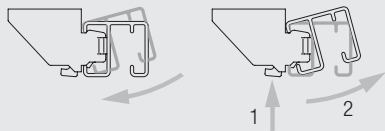

Installation: Roll track onto bracket in direction indicated
Removal: 1. Press to release 2. Rotate forward for removal



Quick-clip glider 3933

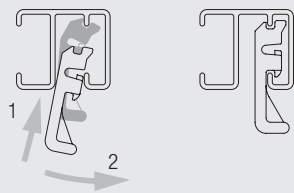

System 1280 is supplied with 3922 roller glider as standard, quick-clip glider 3933 is available as an optional accessory.

Fitting Options

Ceiling fix with bracket 3603

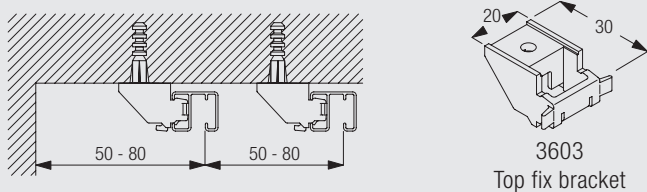

The final distances may be outside of the recommendations above depending on curtain heading, make-up and any obstructions.

Wall fix with universal brackets 3630/3655/3660

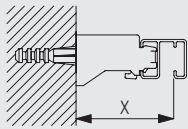

	X (mm)
3630	42
3655	57
3660	72

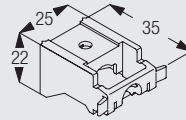

3630
Bracket

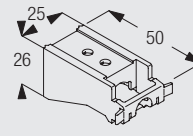

3655
Long universal
bracket

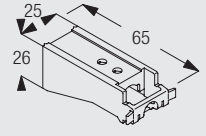

3660
Extra long universal
bracket

Wall fix with brackets 3134-39 and bracket 3603

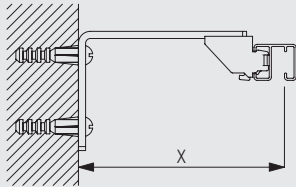

	X (mm)	W (mm)	Y (mm)	Z (mm)
3134	84	-	50	-
3135	104	-	50	50
3136	124	-	50	50
3137	144	-	80	50
3138	174	60	80	60
3139	224	85	80	85

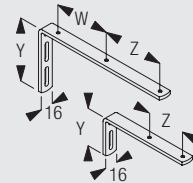

3134-39
Extension brackets
(60-200mm)

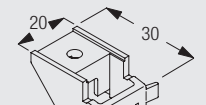

3603
Top fix bracket

Brackets are threaded for screw 6748 (M4 x 8).

Wall fix with extension brackets 3275-77

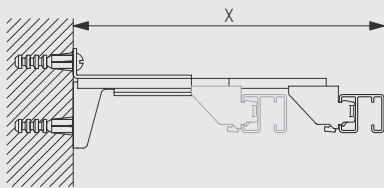

	X (mm)
3275	81-110
3276	104-134
3277	134-164

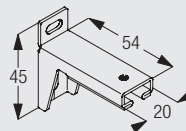

3271
Adjustable bracket
base

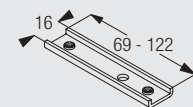

3272-74
Bracket arm

Standard Accessories

18R Screw 25mm. No. 8 roundhead

1280 Profile

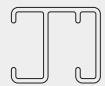

3630 Bracket

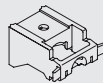

3922 Roller 3911 in strip form



3985 Endcover



1280

Optional Accessories

3133 Bracket cover (60mm)



3134 Extension bracket (60mm)

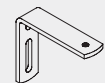

3135 Extension bracket (80mm)

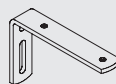

3136 Extension bracket (100mm)

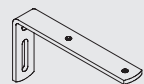



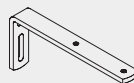



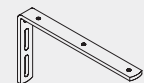

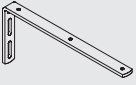

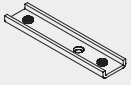
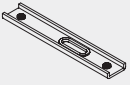
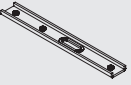

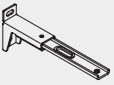
3137 Extension bracket (120mm)

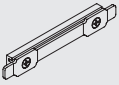
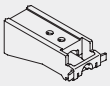

3138 Extension bracket (150mm)

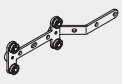
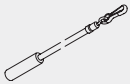

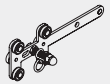
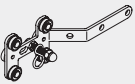
3139	Extension bracket (200mm)		3271	Adjustable bracket base	
3272	Adjustable bracket arm (69mm)		3273	Adjustable bracket arm (92mm)	
3274	Adjustable bracket arm (122mm)		3275	Adjustable extension bracket set (69mm)	
3276	Adjustable extension bracket set (92mm)		3277	Adjustable extension bracket set (122mm)	
3603	Top fix bracket		3620	Connecting bridge	
3660	Extra long universal bracket		3932	Spring stop	
3933	Glider 3933 in strip form		3942	Endstop	
3975	Overlap arm for pulling by hand		4092	Plastic draw rod (4092S Aluminium)	
6748	Cheese head machine screw (M4)	No Drawing needed	3133L	Extended bracket cover for 3138/9	
3935A	Overlap arm straight with S-hook 3949		3936A	Overlap arm with s-hook 3949	

Useful Information and Sewing Accessories



1280

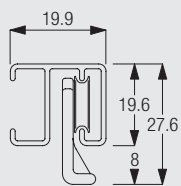



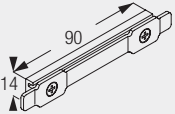

Diagram uses standard 3922 glider and is measured to the inside of the glider eye. For optional gliders substitute dimensions below:
 3945/3946 = 8mm
 3933 = 8mm

3562	Standard tape		3582	Hook	
3599	Hook				

Useful Measurements

3620	Connecting bridge	
------	-------------------	---



1280

www.silentgliss.co.uk

Silent Gliss Ltd
Pyramid Business Park
Poorhole Lane
Broadstairs
Kent
CT10 2PT
Great Britain

Tel: 0044 (0) 1843 863571
Fax: 0044 (0) 1843 864503
sales@silentgliss.co.uk