

Hand Operated Curtain Track Systems

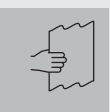



Hand Operated Curtain Track System

Silent Gliss® 1200

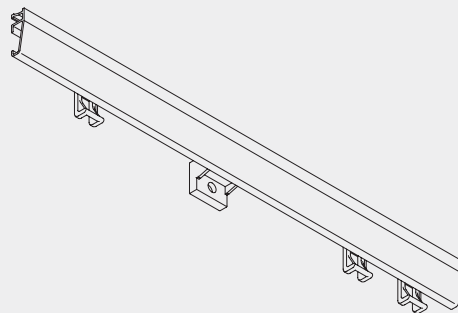

Product Information

- Robust and versatile wall and ceiling fix hand operated curtain track.
- For light to medium weight curtains.
- Patented glider which glides on the profile edge, minimizing friction.
- The quick-clip gliders 3933 can be easily added or removed without taking track down or apart.
- Easy ceiling or wall fix to all surfaces.
- Standard colour: white powder coated.
- Metallic line colours available are silver anodised, black, anthracite, gunmetal, brushed aluminium and chrome effect.
- Standard length of the profiles is 6m, with the exception of chrome, anthracite and brushed aluminium which are available in 4m lengths.
- Can be bent.



1200

Profile, Bending and Specification Information

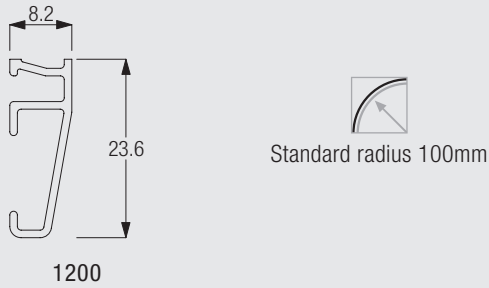

The standard radius is recommended for optimal operation.

Specification Guide - download from the Silent Gliss Extranet

Silent Gliss 1200 hand drawn curtain track in white powder-coated aluminium. Fix to wall with brackets 3175/ceiling with brackets 3176 every 60cm. Special gliders should be fitted at 10/m to run on back rims of channel so as to keep curtain heading upright. Fit with end covers 3986 at either end.

Fitting Information

Bracket positioning and fixing with 3175 and 3176

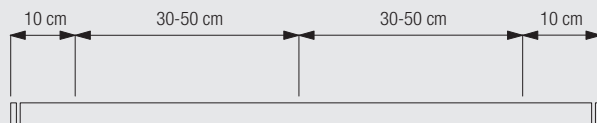

The fixing distances are meant as guide only: they may vary in practice depending on surface or curtain weight.

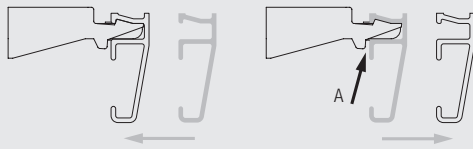

Installation: push track on bracket in direction indicated
Removal: place screwdriver where indicated (A) and twist. Pull track away from bracket

1200

Quick-clip glider 3933

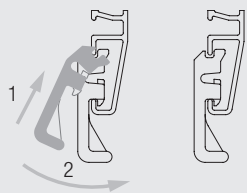

Easily clipped in and out of profile.

Fitting Options

Ceiling fix with bracket 3176

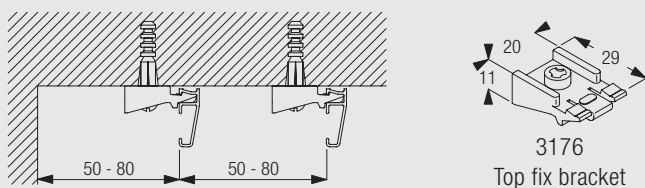

Wall fix with bracket 3175

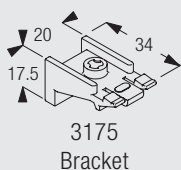
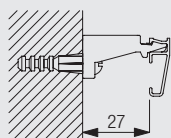

Standard Accessories

18R	Screw 25mm. No. 8 roundhead		1200	Profile	
3175	Bracket		3933	Glider 3933 in strip form	
3986	Endcover (white, black, grey and dark grey)				

Optional Accessories

3113	5cm spacer for double fixing		3115	7cm spacer for double fixing	
3133	Bracket cover (60mm)		3134	Extension bracket (60mm)	
3135	Extension bracket (80mm)		3136	Extension bracket (100mm)	
3137	Extension bracket (120mm)		3138	Extension bracket (150mm)	
3139	Extension bracket (200mm)		3176	Top fix bracket	
3271	Adjustable bracket base		3272	Adjustable bracket arm (69mm)	
3273	Adjustable bracket arm (92mm)		3274	Adjustable bracket arm (122mm)	
3275	Adjustable extension bracket set (69mm)		3276	Adjustable extension bracket set (92mm)	
3277	Adjustable extension bracket set (122mm)		3942	Endstop	
3945	Magnetic glider (part of set 3947)		3946	Magnetic glider (part of set 3947)	
4092	Plastic draw rod (4092S Aluminium)		6748	Cheese head machine screw (M4)	No Drawing needed

3133L Extended bracket cover for 3138/9



Useful Information and Sewing Accessories

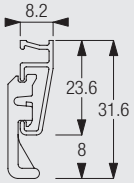
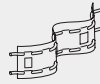

Diagram uses standard 3933 glider and is measured to the inside of the glider eye. For optional gliders substitute dimensions below:
3945/3946 = 8mm

3562 Standard tape



3582 Hook



3599 Hook



1200



1200

www.silentgliss.co.uk

Silent Gliss Ltd
Pyramid Business Park
Poorhole Lane
Broadstairs
Kent
CT10 2PT
Great Britain

Tel: 0044 (0) 1843 863571
Fax: 0044 (0) 1843 864503
sales@silentgliss.co.uk